



This attachment is approved but not supplied by JCB.

## **WHEELED EXCAVATOR | JS175W**

Engine power: 129kW (173hp) | Bucket capacity: 0.25 – 0.87m<sup>3</sup> | Operating weight: 16,256 – 18,982kg





# STRENGTH & DURABILITY.

With JCB excavators, strength and durability come as standard. Advanced design, manufacturing and assembly produces high quality components designed to last.

## MINIMUM DOWNTIME.

Automatic regeneration minimises downtime, while features such as autostop and auto-idle reduce idle time.



## PRODUCTIVITY & PERFORMANCE.

Our wheeled excavator range is designed to make the most efficient use of your time and money using innovative Stage V features.

## A COMFORTABLE OFFICE.

Our excavator cab houses a range of advanced technology features alongside ergonomic design, to create a comfortable working environment for operators.



## GREATER SERVICEABILITY.

Our excavator range is designed to be low maintenance and easily serviceable. When maintenance needs to be carried out, it will be quick and easy.

## THE SAFE CHOICE.

Operator and site safety are of major importance. That's why our machines incorporate many features that minimise risk and create a safer environment.

STATIC DIMENSIONS

MAX. OPERATING WEIGHT: 18982kg ENGINE POWER: 129kW (173hp)

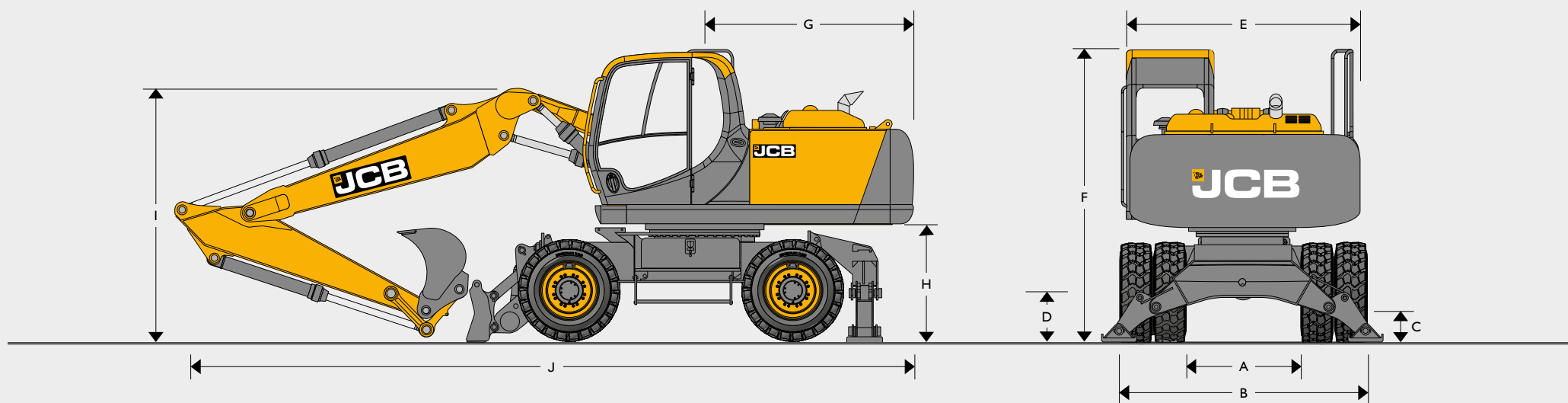

STATIC DIMENSIONS

A	Internal width between dual wheels	mm	1330
B	External width over dual wheels	mm	2498 (JCB), 2528 (ZF)
C	Ground clearance	mm	350
D	Height to axle centre line dual wheels	mm	498
	Height to axle centre line single wheels	mm	519
E	Overall width (handrail removed)	mm	2480
F	Height over cab	mm	3195
G	Tail length	mm	2330
H	Clearance under counterweight	mm	1270

Monoboam 5.15m

Dipper length		2.25m	2.70m	3.05m
I	Transport boom height	mm	2765	3240
J	Transport length	mm	8285	8446

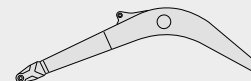

Triple Articulated Boom 4.97m

Dipper length		2.25m	2.70m	3.05m
I	Transport boom height	mm	2806	3136
J	Transport length	mm	8263	8223

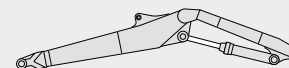

CHASSIS OPTIONS

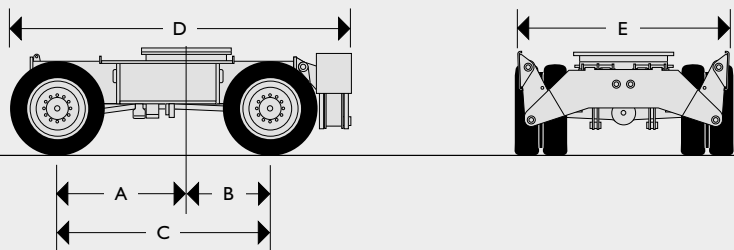

STABILISERS REAR

A	Centre of slew ring to front axle	mm	1500
B	Centre of slew ring to rear axle	mm	1000
C	Wheelbase	mm	2500
D	Length including rear stabilizers	mm	3950
E	Width over stabilizers (raised)	mm	2480

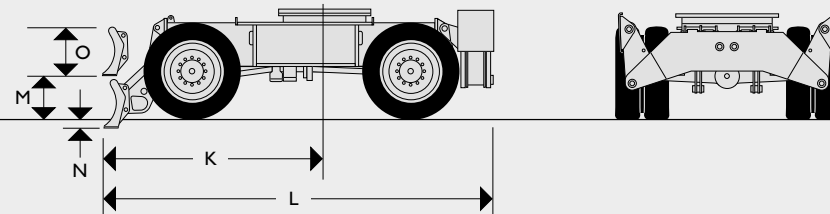

DOZER FRONT STABILISER

K	Centre of slew ring to front dozer blade (lowered)	mm	2530
L	Length including stabilizers and dozer blade (raised)	mm	4460
M	Ground level to bottom of front dozer blade (raised)	mm	450
N	Dozer blade dig depth	mm	130
O	Dozer blade height	mm	500

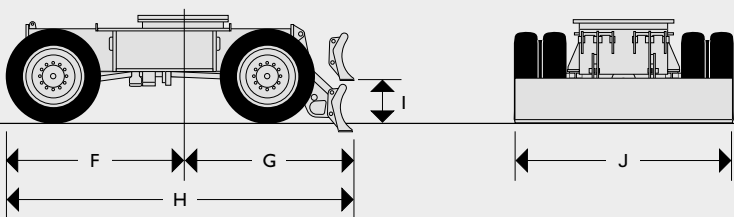

DOZER REAR

F	Centre of slew ring to face of front tyre	mm	1990
G	Centre of slew ring to rear dozer blade (lowered)	mm	2090
H	Length including rear dozer blade (raised)	mm	4050
I	Ground level to bottom of rear dozer blade (raised)	mm	450
J	Dozer blade width	mm	2480

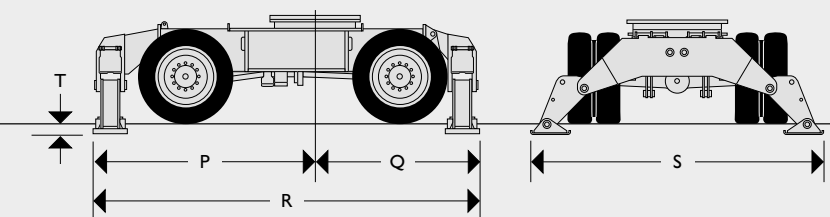

STABILISERS FRONT & REAR

P	Centre of slew ring to front stabilizers	mm	2520
Q	Centre of slew ring to rear stabilizers	mm	1960
R	Length including front and rear stabilizers	mm	4480
S	Width over stabilizers (lowered)	mm	3550
T	Stabilizer lift height	mm	130

ENGINE	
Model	JCB DIESELMAX 448 TCA EU Stage V
Type	4-stroke, 4-cylinder in-line, common rail, direct injection, turbocharged and intercooled diesel.
Rated power (ISO 14396)	129kW (173hp) @2050rpm.
Piston displacement	4.8 litres.
Injection	Electronic injection.
Air filtration	Dry element with secondary safety element and in cab warning indicator.
Cooling	Large capacity radiator.
Starting system	24 volt – 4kW.
Batteries	2 x 12 volt.
Alternator	24 volt 100 amp
Refuelling pump	Electric type (optional).





SWING SYSTEM	
Drive train	Axial piston motor and planetary reduction final drive.
Swing brake	Hydraulic braking plus automatic spring applied disc type parking brake.
Swing speed	11.3 rpm
Swing gear	Large diameter, internally toothed fully sealed grease bath lubricated.
Swing lock	Multi position switchable brake and mechanical lock.

CHASSIS			
Chassis options	2.5m ZF hub brake axles / 2.5m JCB disc brake axle.		
Dozer blade	Front or rear pin mount.		
Stabilisers	Front or rear pin mount, independently operable – plus combinations.		
Grab stowage	Heavy duty, pin mounted stowage bar.		
Axles	Four wheel drive.		
Axle load capacity	25 tonnes (JCB), 32 tonnes (ZF)		
Axle oscillation	+/- 8.5 degrees.		
Ground clearance	350mm.		
Transmission	Hydrostatic drive via piston motor and powershift transmission.		
Travel speed	Creep speed	3.8kph (JCB)	3.8kph (ZF)
	Low ratio	14kph (JCB)	14kph (ZF)
	High ratio	30kph (JCB)	30kph (ZF)
Drawbar pull	99.7 kN (JCB Axle), 102.5 kN (ZF Axle)		
Steering	Fully hydraulic system.		
Turning radius			
	To outside of tyres	6.66m (JCB), 6.22 (ZF)	
	To outer edge of front mounted dozer blade	7.09m (JCB), 6.67 (ZF)	
Brakes	All hydraulic, dual circuit brake system.		
Parking brake	Built into the transmission.		
Gradeability	35° 70% max. continuous.		

TYRES			
	Twins	Single	Flotation
	10.00 x 20 tyres (16PR) with spacer ring	18R x 19.5 tyres (Radials)	600/40 x 22.5

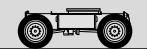

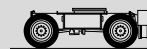
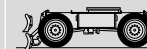
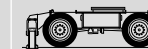
**OPERATING WEIGHTS**

Chassis					
	16256kg	17126kg	17241kg	18111kg	18226kg
	17012kg	17883kg	17997kg	18868kg	18982kg

Machine equipped with 3.05m dipper, excavating bucket and dual wheels. For single wheels subtract 400kg.

**BUCKET AND ARM COMBINATION**

Arm length	No quickhitch fitted			Quickhitch fitted*			Bucket weight
	2.25m	2.7m	3.05m	2.25m	2.7m	3.05m	
<b>JSI75W Mono</b>							
GP bucket 457mm 0.25m <sup>3</sup>	□	□	□	□	□	□	348kg
GP bucket 610mm 0.33m <sup>3</sup>	□	□	□	□	□	□	381kg
GP bucket 762mm 0.46m <sup>3</sup>	□	□	□	□	□	■	428kg
GP bucket 1067mm 0.73m <sup>3</sup>	■	■	●	●	●	×	526kg
GP bucket 1219mm 0.87m <sup>3</sup>	●	●	×	×	×	×	580kg
<b>JSI75W Tab</b>							
GP bucket 457mm 0.25m <sup>3</sup>	□	□	□	□	□	□	348kg
GP bucket 610mm 0.33m <sup>3</sup>	□	□	□	□	□	□	381kg
GP bucket 762mm 0.46m <sup>3</sup>	□	□	□	□	□	■	428kg
GP bucket 1067mm 0.73m <sup>3</sup>	■	■	●	●	●	×	526kg
GP bucket 1219mm 0.87m <sup>3</sup>	●	●	×	×	×	×	580kg

Notes: Bucket compatibility based upon lift values (ISO 10567) for a rear dozer machine, compatibility will change based upon chassis options.

□ = Suitable for general excavating (materials up to 2000kg/cu.m.)

■ = Suitable for light excavating (materials up to 1600kg/cu.m.)

● = Suitable for grading & loading (materials up to 1200kg/cu.m.)

× = Not recommended

\* Bucket capacity using JCB quickhitch only (quickhitch = 288kg).

**SERVICE CAPACITIES**

Fuel tank	litres	310
Engine coolant	litres	26
Engine oil	litres	20.4
Swing reduction gear	litres	6
Hydraulic system	litres	124
Hydraulic tank	litres	73
Transmission	litres	2.5
Axle differentials (each)	litres	Rear 12, Front 14
Axle hubs (each)	litres	2.0
DEF fluid capacity	litres	31.4

**MAIN HYDRAULIC SYSTEM**

<b>System</b>	Open centred, negative control hydraulic system with twin variable flow piston pumps providing flow-on-demand for maximum efficiency.
<b>Main pumps</b>	2 variable displacement axial piston type.
Maximum flow	2 x 156 l/min.
Main circuit pressure	314 bar.
With power boost	343 bar.
<b>Servo pump</b>	Gear type.
Maximum flow	27 l/min.
Servo pressure	40 bar.
<b>Optional circuits</b>	
<b>Hammer</b>	Includes automatic engine speed setting and return filter.
Maximum flow	138 l/min.
Maximum pressure	314 bar (pre-set to 180 bar).
<b>Aux double acting</b>	
Maximum flow	130 l/min.
Maximum pressure for grab ram operation	314 (343) bar.
<b>Low flow pipework</b>	Gear pump max flow 36 l/min.
<b>Hydraulic cylinders</b>	Hardened, chromed piston rods and end cushioning on boom, dipper and bucket crowd cylinder.
<b>Filtration</b>	
In tank	150 micron, suction strainer.
Main return line	10 micron, fibreform element.
Pilot line	10 micron, paper element.
Hydraulic hammer return	10 micron, reinforced microform element.
<b>Cooling</b>	Worldwide cooling is provided by a single faced engine water, hydraulic oil and intercooler with swing forwards air conditioning condenser for easy cleaning.

WORKING RANGES

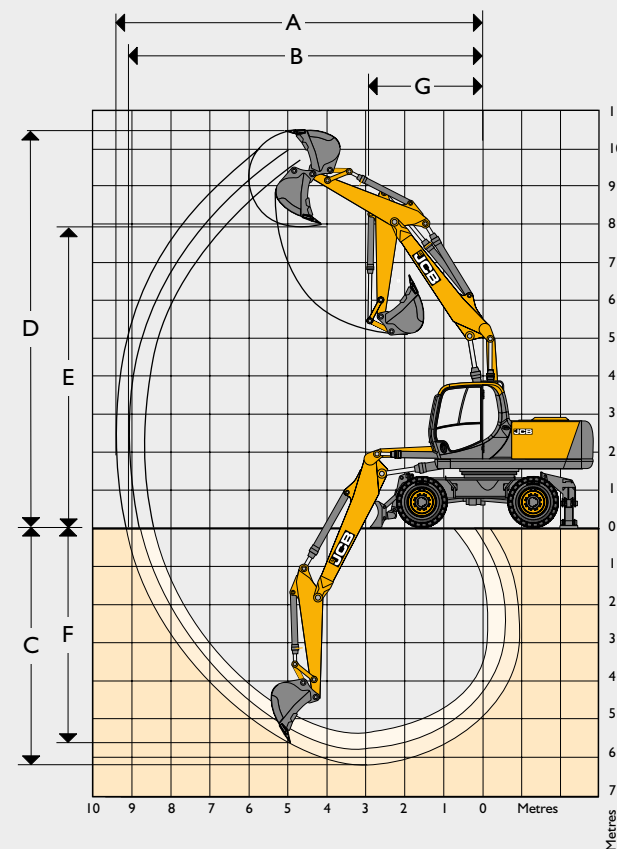
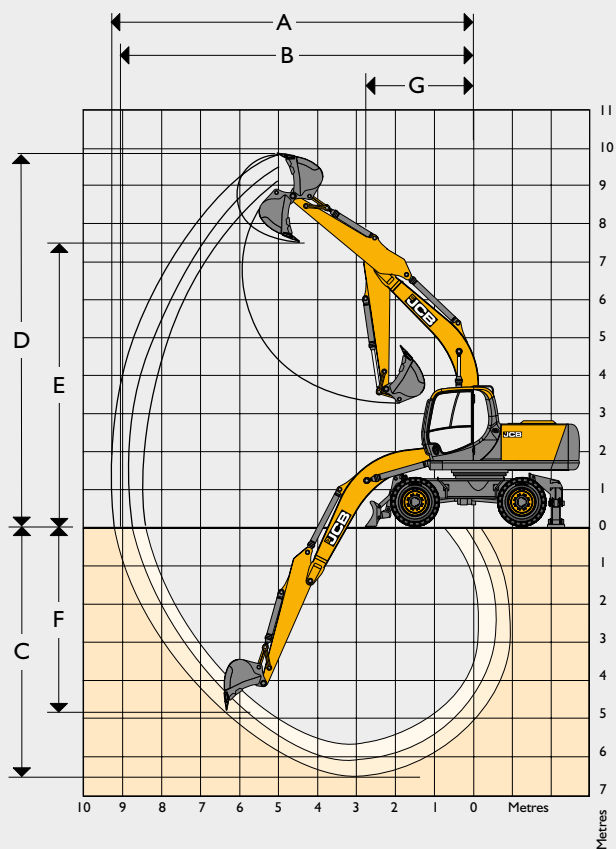

5.15m Monoboom





Dipper length		2.25m	2.70m	3.05m	
A	Max digging reach	mm	8592	8974	9483
B	Max digging reach (on ground)	mm	8386	8776	9234
C	Max digging depth	mm	5682	6120	6256
D	Max digging height	mm	9102	9237	9688
E	Max loadover height	mm	6636	6805	7174
F	Max vertical wall cut depth	mm	3826	4178	4839
G	Min swing radius	mm	3019	2961	2971
	Bucket rotation		183°	183°	183°
	Dipper tearout	kgf	10128	8440	7470
	Dipper tearout with boost	kgf	10990	9160	8100
	Bucket tearout	kgf	10400	10400	10400
	Bucket tearout with boost	kgf	10740	10740	10740

4.97m T.A.B.

Dipper length		2.25m	2.70m	3.05m	
A	Max digging reach	mm	8600	9025	9350
B	Max digging reach (on ground)	mm	8400	8850	9195
C	Max digging depth	mm	5300	5750	6100
D	Max digging height	mm	9700	10000	10235
E	Max loadover height	mm	7000	7325	7575
F	Max vertical wall cut depth	mm	4450	4900	5250
G	Min swing radius	mm	2725	2675	2635
	Bucket rotation		183°	183°	183°
	Dipper tearout	kgf	9035	7530	6665
	Dipper tearout with boost	kgf	9600	8100	7235
	Bucket tearout	kgf	10400	10400	10400
	Bucket tearout with boost	kgf	10740	10740	10740

LIFT CAPACITIES – DIPPER LENGTH: 2.25M, 5.15M MONOBOOM, REAR DOZER, NO BUCKET.													JSI75W MONO
Reach	1.5m		3m		4.5m		6m		7.5m		Capacity at Max Reach		
													
Load Point Ht.	kg	kg	kg	kg	kg	kg	kg	kg	kg	kg	kg	kg	mm
7.5m					4360*	4360*					3830*	3830*	4620
6.0m					5080*	4470	3530*	2760			3330*	2740	6031
4.5m					5710*	4260	4890*	2730			3190*	2190	6838
3.0m					6740*	3940	5250*	2600			3230*	1940	7248
1.5m					7530*	3650	5580*	2470			3440*	1850	7330
0m			5580*	5580*	7600*	3510	5600*	2380			3880*	1910	7094
- 1.5m	6310*	6310*	9440*	6460	6950*	3490	5060*	2370			4400*	2150	6508
- 3.0m	8760*	8760*	7190*	6620	5360*	3580					4000*	2790	5454
- 4.5m			2810*	2810*							2280*	2280*	3524

LIFT CAPACITIES – DIPPER LENGTH: 2.70M, 5.15M MONOBOOM, REAR DOZER, NO BUCKET.													JSI75W MONO	
Reach	1.5m		3m		4.5m		6m		7.5m		Capacity at Max Reach			
														
Load Point Ht.	kg	kg	kg	kg	kg	kg	kg	kg	kg	kg	kg	kg	mm	
7.5m												2880*	2880*	5238
6.0m							4040*	2860				2580*	2460	6514
4.5m					5290*	4370	4610*	2780				2500*	2010	7266
3.0m			9710*	7300	6360*	4010	5040*	2630	3370*	1860		2540*	1800	7653
1.5m			5120*	5120*	7290*	3680	5450*	2480	4100*	1800		2690*	1710	7731
0m			6660*	6250	7590*	3480	5600*	2360	3080*	1750		3020*	1750	7508
- 1.5m	6070*	6070*	10140*	6280	7170*	3420	5280*	2320				3630*	1930	6957
- 3.0m	10160*	10160*	8130*	6430	5930*	3480						4020*	2400	5985
- 4.5m			4570*	4570*								3120*	3120*	4307



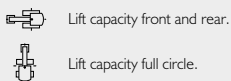









LIFT CAPACITIES – DIPPER LENGTH: 3.05M, 5.15M MONOBOOM, REAR DOZER, NO BUCKET.													JSI75W MONO	
Reach	1.5m		3m		4.5m		6m		7.5m		Capacity at Max Reach			
														
Load Point Ht.	kg	kg	kg	kg	kg	kg	kg	kg	kg	kg	kg	kg	mm	
7.5m												2400*	2400*	5690
6.0m							3840*	2860				2170*	2170	6881
4.5m							4350*	2780	2500*	1890		2110*	1840	7596
3.0m			8930*	7540	6020*	4060	4830*	2630	3790*	1840		2150*	1650	7967
1.5m			6790*	6590	7070*	3700	5300*	2460	4270	1760		2280*	1580	8041
0m			6950*	6270	7540*	3470	5540*	2340	4200	1710		2540*	1600	7828
- 1.5m	5610*	5610*	9860*	6240	7290*	3390	5350*	2280				3040*	1760	7301
- 3.0m	9050*	9050*	8780*	6350	6260*	3420	4430*	2310				3920*	2140	6383
- 4.5m	7560*	7560*	5630*	5630*	3860*	3600						3340*	3260	4849









- Notes:
1. For lifting capacity including bucket, subtract total weight of bucket or bucket and quickhitch from above values.
  2. Lifting capacities are based on ISO 10567, that is: 75% of minimum tipping load or 87% of hydraulic lift capacity, whichever is the less. Lifting capacities marked\* are based on hydraulic capacity.
  3. Lift capacities assume that the machine is on firm, level ground.
  4. Lift capacities may be limited by local regulations. Please refer to your dealer.









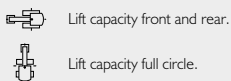

LIFT CAPACITIES – DIPPER LENGTH: 2.25M, 5.15M MONOBOOM, REAR STABILISERS, NO BUCKET.													JSI75W MONO
Reach	1.5m		3m		4.5m		6m		7.5m		Capacity at Max Reach		
													
Load Point Ht.	kg	kg	kg	kg	kg	kg	kg	kg	kg	kg	kg	kg	mm
7.5m					4360*	4360*					3830*	3830*	4620
6.0m					5080*	5080*	3530*	3260			3330*	3230	6031
4.5m					5710*	5050	4890*	3220			3190*	2590	6838
3.0m					6740*	4710	4980	3090			3230*	2310	7248
1.5m					7530*	4420	4830	2950			3440*	2220	7330
0m			5580*	5580*	7450	4260	4730	2860			3710	2290	7094
- 1.5m	6310*	6310*	9440*	8090	6950*	4240	4720	2850			4200	2570	6508
- 3.0m	8760*	8760*	7190*	7190*	5360*	4340					4000*	3350	5454
- 4.5m			2810*	2810*							2280*	2280*	3524







LIFT CAPACITIES – DIPPER LENGTH: 2.70M, 5.15M MONOBOOM, REAR STABILISERS, NO BUCKET.													JSI75W MONO
Reach	1.5m		3m		4.5m		6m		7.5m		Capacity at Max Reach		
													
Load Point Ht.	kg	kg	kg	kg	kg	kg	kg	kg	kg	kg	kg	kg	mm
7.5m											2880*	2880*	5238
6.0m							4040*	3350			2580*	2580*	6514
4.5m					5290*	5160	4610*	3280			2500*	2380	7266
3.0m			9710*	9010	6360*	4790	5030	3120	3370*	2210	2540*	2140	7653
1.5m			5120*	5120*	7290*	4440	4850	2960	3460	2150	2690*	2050	7731
0m			6660*	6660*	7420	4230	4720	2850	3080*	2110	3020*	2100	7508
- 1.5m	6070*	6070*	10140*	7900	7170*	4170	4670	2810			3630*	2320	6957
- 3.0m	10160*	10160*	8130*	8060	5930*	4240					4020*	2890	5985
- 4.5m			4570*	4570*							3120*	3120*	4307













LIFT CAPACITIES – DIPPER LENGTH: 3.05M, 5.15M MONOBOOM, REAR STABILISERS, NO BUCKET.													JSI75W MONO
Reach	1.5m		3m		4.5m		6m		7.5m		Capacity at Max Reach		
													
Load Point Ht.	kg	kg	kg	kg	kg	kg	kg	kg	kg	kg	kg	kg	mm
7.5m											2400*	2400*	5690
6.0m							3840*	3360			2170*	2170*	6881
4.5m							4350*	3270	2500*	2250	2110*	2110*	7596
3.0m			8930*	8930*	6020*	4840	4830*	3120	3510	2190	2150*	1980	7967
1.5m			6790*	6790*	7070*	4470	4840	2950	3430	2120	2280*	1800	8041
0m			6950*	6950*	7430	4230	4649	2820	3360	2060	2540*	1940	7828
- 1.5m	5610*	5610*	9860*	7860	7290*	4140	4620	2760			3040*	2120	7301
- 3.0m	9050*	9050*	8780*	7990	6260*	4170	4430*	2790			3920*	2590	6383
- 4.5m	7560*	7560*	5630*	5630*	3860*	3860*					3340*	3340*	4849



- Notes:
1. For lifting capacity including bucket, subtract total weight of bucket or bucket and quickhitch from above values.
  2. Lifting capacities are based on ISO 10567, that is: 75% of minimum tipping load or 87% of hydraulic lift capacity, whichever is the less. Lifting capacities marked\* are based on hydraulic capacity.
  3. Lift capacities assume that the machine is on firm, level ground.
  4. Lift capacities may be limited by local regulations. Please refer to your dealer.

LIFT CAPACITIES – DIPPER LENGTH: 2.25M, 5.15M MONOBOOM, FRONT DOZER, REAR STABILISERS, NO BUCKET.													JSI75W MONO
Reach	1.5m		3m		4.5m		6m		7.5m		Capacity at Max Reach		
													
Load Point Ht.	kg	kg	kg	kg	kg	kg	kg	kg	kg	kg	kg	kg	mm
7.5m					4360*	4360*					3830*	3830*	4620
6.0m					5080*	5080*	3530*	3530*			3330*	3330*	6031
4.5m					5710*	5710*	4890*	4110			3190*	3090*	6838
3.0m					6740*	6160	5250*	3970			3230*	2980	7248
1.5m					7530*	5830	5580*	3830			3440*	2870	7330
0m			5580*	5580*	7600*	5670	5600*	3740			3880*	2970	7094
- 1.5m	6310*	6310*	9440*	9440*	6950*	5650	5060*	3730			4400*	3350	6508
- 3.0m	8760*	8760*	7190*	7190*	5360*	5360*					4000*	4000*	5454
- 4.5m			2810*	2810*							2280*	2280*	3524

LIFT CAPACITIES – DIPPER LENGTH: 2.70M, 5.15M MONOBOOM, FRONT DOZER, REAR STABILISERS, NO BUCKET.													JSI75W MONO
Reach	1.5m		3m		4.5m		6m		7.5m		Capacity at Max Reach		
													
Load Point Ht.	kg	kg	kg	kg	kg	kg	kg	kg	kg	kg	kg	kg	mm
7.5m											2880*	2880*	5238
6.0m							4040*	4040*			2580*	2580*	6514
4.5m					5290*	5290*	4610*	4170			2500*	2500*	7266
3.0m			9710*	9710*	6360*	6240	5040*	4010	3370*	2850	2540*	2540*	7653
1.5m			5120*	5120*	7290*	5860	5450*	3840	4100*	2780	2690*	2660	7731
0m			6660*	6660*	7590*	5640	5600*	3720	3080*	2740	3020*	2730	7508
- 1.5m	6070*	6070*	10140*	10140*	7170*	5570	5280*	3680			3630*	3030	6957
- 3.0m	10160*	10160*	8130*	8130*	5930*	5640					4020*	3770	5985
- 4.5m			4570*	4570*							3120*	3120*	4307

LIFT CAPACITIES – DIPPER LENGTH: 3.05M, 5.15M MONOBOOM, FRONT DOZER, REAR STABILISERS, NO BUCKET.													JSI75W MONO
Reach	1.5m		3m		4.5m		6m		7.5m		Capacity at Max Reach		
													
Load Point Ht.	kg	kg	kg	kg	kg	kg	kg	kg	kg	kg	kg	kg	mm
7.5m											2400*	2400*	5690
6.0m							3840*	3840*			2170*	2170*	6881
4.5m							4350*	4170	2500*	2500*	2110*	2110*	7596
3.0m			8930*	8930*	6020*	6020*	4830*	4010	3790*	2830	2150*	2150*	7967
1.5m			6790*	6790*	7070*	5900	5300*	3830	4330*	2750	2280*	2280*	8041
0m			6950*	6950*	7540*	5640	5540*	3700	4320*	2690	2540*	2530	7828
- 1.5m	5610*	5610*	9860*	9860*	7290*	5540	5350*	3630			3040*	2780	7301
- 3.0m	9050*	9050*	8780*	8780*	6260*	5580	4430*	3670			3920*	3380	6383
- 4.5m	7560*	7560*	5630*	5630*	3860*	3860*					3340*	3340*	4849

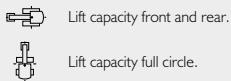







Notes:

1. For lifting capacity including bucket, subtract total weight of bucket or bucket and quickhitch from above values.
2. Lifting capacities are based on ISO 10567, that is: 75% of minimum tipping load or 87% of hydraulic lift capacity, whichever is the less. Lifting capacities marked\* are based on hydraulic capacity.
3. Lift capacities assume that the machine is on firm, level ground.
4. Lift capacities may be limited by local regulations. Please refer to your dealer.













**LIFT CAPACITIES – DIPPER LENGTH: 2.25M, 5.15M MONOBOOM, FRONT STABILISERS, REAR STABILISERS, NO BUCKET. JSI75W MONO**

Reach	1.5m		3m		4.5m		6m		7.5m		Capacity at Max Reach			
														mm
Load Point Ht.	kg	kg	kg	kg	kg	kg	kg	kg	kg	kg	kg	kg	kg	mm
7.5m					4360*	4360*					3830*	3830*	4620	
6.0m					5080*	5080*	3530*	3530*			3330*	3330*	6031	
4.5m					5710*	5710*	4890*	4670			3190*	3190*	6838	
3.0m					6740*	6740*	5250*	4520			3230*	3230*	7248	
1.5m					7530*	6750	5580*	4380			3440*	3270	7330	
0m			5580*	5580*	7600*	6580	5600*	4280			3880*	3390	7094	
- 1.5m	6310*	6310*	9440*	9440*	6950*	6550	5060*	4270			4400*	3830	6508	
- 3.0m	8760*	8760*	7190*	7190*	5360*	5360*					4000*	4000*	5454	
- 4.5m			2810*	2810*							2280*	2280*	3524	

**LIFT CAPACITIES – DIPPER LENGTH: 2.70M, 5.15M MONOBOOM, FRONT STABILISERS, REAR STABILISERS, NO BUCKET. JSI75W MONO**







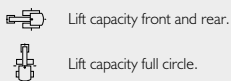





Reach	1.5m		3m		4.5m		6m		7.5m		Capacity at Max Reach			
														mm
Load Point Ht.	kg	kg	kg	kg	kg	kg	kg	kg	kg	kg	kg	kg	kg	mm
7.5m												2880*	2880*	5238
6.0m							4040*	4040*				2580*	2580*	6514
4.5m						5290*	5290*	4610*	4610*			2500*	2500*	7266
3.0m			9710*	9710*	6360*	6360*	5040*	4570	3370*	3240		2540*	2540*	7653
1.5m			5120*	5120*	7290*	6780	5450*	4390	4100*	3170		2690*	2690*	7731
0m			6660*	6660*	7590*	6550	5600*	4270	3080*	3080		3020*	3020	7508
- 1.5m	6070*	6070*	10140*	10140*	7170*	6480	5280*	4220				3630*	3460	6957
- 3.0m	10160*	10160*	8130*	8130*	5930*	5930*						4020*	4020*	5985
- 4.5m			4570*	4570*								3120*	3120*	4307

**LIFT CAPACITIES – DIPPER LENGTH: 3.05M, 5.15M MONOBOOM, FRONT STABILISERS, REAR STABILISERS, NO BUCKET. JSI75W MONO**









Reach	1.5m		3m		4.5m		6m		7.5m		Capacity at Max Reach			
														mm
Load Point Ht.	kg	kg	kg	kg	kg	kg	kg	kg	kg	kg	kg	kg	kg	mm
7.5m												2400*	2400*	5690
6.0m							3840*	3840*				2170*	2170*	6881
4.5m							4350*	4350*	2500*	2500*		2110*	2110*	7596
3.0m			8930*	8930*	6020*	6020*	4830*	4560	3790*	3220		2150*	2150*	7967
1.5m			6790*	6790*	7070*	6820	5300*	4380	4330*	3140		2280*	2280*	8041
0m			6950*	6950*	7540*	6550	5540*	4240	4320*	3070		2540*	2540*	7828
- 1.5m	5610*	5610*	9860*	9860*	7290*	6450	5350*	4180				3040*	3040*	7301
- 3.0m	9050*	9050*	8780*	8780*	6260*	6260*	4430*	4210				3920*	3880	6383
- 4.5m	7560*	7560*	5630*	5630*	3860*	3860*						3340*	3340*	4849



- Notes:**
1. For lifting capacity including bucket, subtract total weight of bucket or bucket and quickhitch from above values.
  2. Lifting capacities are based on ISO 10567, that is: 75% of minimum tipping load or 87% of hydraulic lift capacity, whichever is the less. Lifting capacities marked\* are based on hydraulic capacity.
  3. Lift capacities assume that the machine is on firm, level ground.
  4. Lift capacities may be limited by local regulations. Please refer to your dealer.

LIFT CAPACITIES – DIPPER LENGTH: 2.25M, 4.97M T.A.B., REAR DOZER, NO BUCKET.													JSI75W T.A.B.	
Reach	1.5m		3m		4.5m		6m		7.5m		Capacity at Max Reach		mm	
														
Load Point Ht.	kg	kg	kg	kg	kg	kg	kg	kg	kg	kg	kg	kg	kg	
7.5m												4240*	4240*	4492
6.0m					4690*	4560						3510*	2810	5935
4.5m			6720*	6720*	5250*	4360	4630*	2750				3270*	2230	6753
3.0m					6270*	4020	4990*	2630				3230*	1970	7168
1.5m					7190*	3700	5390*	2480				3350*	1880	7251
0m			5340*	5340*	7530*	3520	5540*	2390				3670*	1940	7013
- 1.5m			10110*	6460	7130*	3500	5140*	2380				4330*	2200	6419
- 3.0m					5670*	3610						5100*	3240	4882

LIFT CAPACITIES – DIPPER LENGTH: 2.70M, 4.97M T.A.B., REAR DOZER, NO BUCKET.													JSI75W T.A.B.	
Reach	1.5m		3m		4.5m		6m		7.5m		Capacity at Max Reach		mm	
														
Load Point Ht.	kg	kg	kg	kg	kg	kg	kg	kg	kg	kg	kg	kg	kg	
7.5m					4410*	4410*						3120*	3120*	5155
6.0m					4240*	4240*	4170*	2880				2700*	2500	6448
4.5m					4820*	4480	4330*	2820				2550*	2040	7207
3.0m			8730*	7550	5870*	4110	4750*	2670	3200*	1860		2530*	1810	7597
1.5m					6900*	3730	5220*	2500	3880*	1800		2630*	1730	7675
0m			6410*	6280	7430*	3500	5490*	2380				2870*	1770	7451
- 1.5m			10500*	6290	7270*	3430	5330*	2330				3340*	1970	6895
- 3.0m			8830*	6460	6230*	3500						4150*	2480	5913



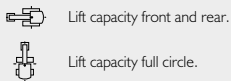









LIFT CAPACITIES – DIPPER LENGTH: 3.05M, 4.97M T.A.B., REAR DOZER, NO BUCKET.													JSI75W T.A.B.	
Reach	1.5m		3m		4.5m		6m		7.5m		Capacity at Max Reach		mm	
														
Load Point Ht.	kg	kg	kg	kg	kg	kg	kg	kg	kg	kg	kg	kg	kg	
7.5m												2580*	2580*	5629
6.0m							3860*	2900				2270*	2250	6831
4.5m					4440*	4440*	4050*	2820	2430*	1880		2150*	1860	7551
3.0m			7950*	7800	5520*	4150	4520*	2670	3790*	1840		2140*	1660	7924
1.5m			6890*	6730	6650*	3760	5040*	2490	4210*	1770		2230*	1590	7998
0m			6710*	6310	7320*	3500	5400*	2350	4210*	1710		2420*	1620	7784
- 1.5m	5120*	5120*	9850*	6250	7330*	3400	5370*	2290				2800*	1790	7254
- 3.0m			9410*	6380	6530*	3430	4540*	2330				3590*	2200	6329















- Notes:
1. For lifting capacity including bucket, subtract total weight of bucket or bucket and quickhitch from above values.
  2. Lifting capacities are based on ISO 10567, that is: 75% of minimum tipping load or 87% of hydraulic lift capacity, whichever is the less. Lifting capacities marked\* are based on hydraulic capacity.
  3. Lift capacities assume that the machine is on firm, level ground.
  4. Lift capacities may be limited by local regulations. Please refer to your dealer.















**LIFT CAPACITIES – DIPPER LENGTH: 2.25M, 4.97M T.A.B., REAR STABILISERS, NO BUCKET. JSI75W T.A.B.**

Reach	1.5m		3m		4.5m		6m		7.5m		Capacity at Max Reach		mm	
														
Load Point Ht.	kg	kg	kg	kg	kg	kg	kg	kg	kg	kg	kg	kg	mm	
7.5m												4240*	4240*	4492
6.0m					4690*	4690*						3510*	3330	5935
4.5m			6720*	6720*	5250*	5170	4630*	3260				3270*	2660	6753
3.0m					6270*	4810	4990*	3130				3230*	2360	7168
1.5m					7190*	4480	4930	2980				3350*	2260	7251
0m			5340*	5340*	7530*	4300	4820	2890				3670*	2340	7013
- 1.5m			10110*	8130	7130*	4270	4810	2880				4330*	2650	6419
- 3.0m					5670*	4390						5100*	3920	4882

**LIFT CAPACITIES – DIPPER LENGTH: 2.70M, 4.97M T.A.B., REAR STABILISERS, NO BUCKET. JSI75W T.A.B.**

Reach	1.5m		3m		4.5m		6m		7.5m		Capacity at Max Reach		mm	
														
Load Point Ht.	kg	kg	kg	kg	kg	kg	kg	kg	kg	kg	kg	kg	mm	
7.5m					4410*	4410*						3120*	3120*	5155
6.0m					4240*	4240*	4170*	3400				2700*	2700*	6448
4.5m					4820*	4820*	4330*	3330				2550*	2430	7207
3.0m			8730*	8730*	5870*	4910	4750*	3180	3200*	2220		2530*	2170	7597
1.5m					6900*	4520	4960	3000	3520	2160		2630*	2090	7675
0m			6410*	6410*	7430*	4280	4810	2870				2870*	2140	7451
- 1.5m			10500*	7950	7270*	4200	4760	2830				3340*	2380	6895
- 3.0m			8830*	8140	6230*	4280						4150*	2990	5913

**LIFT CAPACITIES – DIPPER LENGTH: 3.05M, 4.97M T.A.B., REAR DOZER, NO BUCKET. JSI75W T.A.B.**

Reach	1.5m		3m		4.5m		6m		7.5m		Capacity at Max Reach		mm	
														
Load Point Ht.	kg	kg	kg	kg	kg	kg	kg	kg	kg	kg	kg	kg	mm	
7.5m												2580*	2580*	5629
6.0m							3860*	3420				2270*	2270*	6831
4.5m					4440*	4440*	4050*	3340	2430*	2250		2150*	2150*	7551
3.0m			7950*	7950*	5520*	4960	4520*	3180	3580	2210		2140*	2000	7924
1.5m			6890*	6890*	6650*	4550	4950	2990	3490	2130		2230*	1920	7998
0m			6710*	6710*	7320*	4280	4790	2850	3430	2070		2420*	1970	7784
- 1.5m	5120*	5120*	9850*	7920	7330*	4170	4710	2780				2800*	2170	7254
- 3.0m			9410*	8050	6530*	4210	4540*	2830				3590*	2660	6329

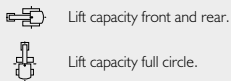

- Notes:**
1. For lifting capacity including bucket, subtract total weight of bucket or bucket and quickhitch from above values.
  2. Lifting capacities are based on ISO 10567, that is: 75% of minimum tipping load or 87% of hydraulic lift capacity, whichever is the less. Lifting capacities marked\* are based on hydraulic capacity.
  3. Lift capacities assume that the machine is on firm, level ground.
  4. Lift capacities may be limited by local regulations. Please refer to your dealer.

**LIFT CAPACITIES – DIPPER LENGTH: 2.25M, 4.97M T.A.B., FRONT DOZER, REAR STABILISERS, NO BUCKET. JSI75W T.A.B.**

Reach	1.5m		3m		4.5m		6m		7.5m		Capacity at Max Reach		mm	
														
Load Point Ht.	kg	kg	kg	kg	kg	kg	kg	kg	kg	kg	kg	kg	kg	
7.5m												4240*	4240*	4492
6.0m					4690*	4690*						3510*	3510*	5935
4.5m			6720*	6720*	5250*	5250*	4630*	4180				3270*	3270*	6753
3.0m					6270*	6270*	4990*	4040				3230*	3050	7168
1.5m					7190*	5940	5390*	3890				3350*	2950	7251
0m			5340*	5340*	7530*	5750	5540*	3790				3670*	3060	7013
- 1.5m			10110*	10110*	7130*	5710	5140*	3780				4330*	3470	6419
- 3.0m					5670*	5670*						5100*	5100*	4882

**LIFT CAPACITIES – DIPPER LENGTH: 2.70M, 4.97M T.A.B., FRONT DOZER, REAR STABILISERS, NO BUCKET. JSI75W T.A.B.**

Reach	1.5m		3m		4.5m		6m		7.5m		Capacity at Max Reach		mm	
														
Load Point Ht.	kg	kg	kg	kg	kg	kg	kg	kg	kg	kg	kg	kg	kg	
7.5m					4410*	4410*						3120*	3120*	5155
6.0m					4240*	4240*	4170*	4170*				2700*	2700*	6448
4.5m					4820*	4820*	4330*	4260				2550*	2550*	7207
3.0m			8730*	8730*	5870*	5870*	4750*	4090	3200*	2880		2530*	2530*	7597
1.5m					6900*	5980	5220*	3910	3880*	2810		2630*	2630*	7675
0m			6410*	6410*	7430*	5720	5490*	3770				2870*	2800	7451
- 1.5m			10500*	10500*	7270*	5640	5330*	3730				3340*	3110	6895
- 3.0m			8830*	8830*	6230*	5720						4150*	3910	5913

**LIFT CAPACITIES – DIPPER LENGTH: 3.05M, 4.97M T.A.B., FRONT DOZER, REAR STABILISERS, NO BUCKET. JSI75W T.A.B.**

Reach	1.5m		3m		4.5m		6m		7.5m		Capacity at Max Reach		mm	
														
Load Point Ht.	kg	kg	kg	kg	kg	kg	kg	kg	kg	kg	kg	kg	kg	
7.5m												2580*	2580*	5629
6.0m							3860*	3860*				2270*	2270*	6831
4.5m					4440*	4440*	4050*	4050*	2430*	2430*		2150*	2150*	7551
3.0m			7950*	7950*	5520*	5520*	4520*	4090	3790*	2870		2140*	2140*	7924
1.5m			6890*	6890*	6650*	6020	5040*	3900	4210*	2790		2230*	2230*	7998
0m			6710*	6710*	7320*	5730	5400*	3750	4210*	2720		2420*	2420*	7784
- 1.5m	5120*	5120*	9850*	9850*	7330*	5610	5370*	3680				2800*	2800*	7254
- 3.0m			9410*	9410*	6530*	5650	4540*	3730				3590*	3490	6329

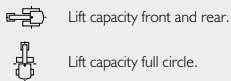







- Notes:**
1. For lifting capacity including bucket, subtract total weight of bucket or bucket and quickhitch from above values.
  2. Lifting capacities are based on ISO 10567, that is: 75% of minimum tipping load or 87% of hydraulic lift capacity, whichever is the less. Lifting capacities marked\* are based on hydraulic capacity.
  3. Lift capacities assume that the machine is on firm, level ground.
  4. Lift capacities may be limited by local regulations. Please refer to your dealer.



**LIFT CAPACITIES – DIPPER LENGTH: 2.25M, 4.97M T.A.B., FRONT STABILISERS, REAR STABILISERS, NO BUCKET. JSI75W T.A.B.**

Reach	1.5m		3m		4.5m		6m		7.5m		Capacity at Max Reach		mm	
														
Load Point Ht.	kg	kg	kg	kg	kg	kg	kg	kg	kg	kg	kg	kg	kg	
7.5m												4240*	4240*	4492
6.0m					4690*	4690*						3510*	3510*	5935
4.5m			6720*	6720*	5250*	5250*	4630*	4630*				3270*	3270*	6753
3.0m					6270*	6270*	4990*	4610				3230*	3230*	7168
1.5m					7190*	6880	5390*	4450				3350*	3350*	7251
0m			5340*	5340*	7530*	6680	5540*	4340				3670*	3490	7013
- 1.5m			10110*	10110*	7130*	6640	5140*	4330				4330*	3970	6419
- 3.0m					5670*	5670*						5100*	5100*	4882

**LIFT CAPACITIES – DIPPER LENGTH: 2.70M, 4.97M T.A.B., FRONT STABILISERS, REAR STABILISERS, NO BUCKET. JSI75W T.A.B.**

Reach	1.5m		3m		4.5m		6m		7.5m		Capacity at Max Reach		mm	
														
Load Point Ht.	kg	kg	kg	kg	kg	kg	kg	kg	kg	kg	kg	kg	kg	
7.5m					4410*	4410*						3120*	3120*	5155
6.0m					4240*	4240*	4170*	4170*				2700*	2700*	6448
4.5m					4820*	4820*	4330*	4330*				2550*	2550*	7207
3.0m			8730*	8730*	5870*	5870*	4750*	4660	3200*	3200*		2530*	2530*	7597
1.5m					6900*	6900*	5220*	4470	3880*	3210		2630*	2630*	7657
0m			6410*	6410*	7430*	6660	5490*	4330				2870*	2870*	7451
- 1.5m			10500*	10500*	7270*	6570	5330*	4290				3340*	3340*	6895
- 3.0m			8830*	8830*	6230*	6230*						4150*	4150*	5913

**LIFT CAPACITIES – DIPPER LENGTH: 3.05M, 4.97M T.A.B., FRONT STABILISERS, REAR STABILISERS, NO BUCKET. JSI75W T.A.B.**

Reach	1.5m		3m		4.5m		6m		7.5m		Capacity at Max Reach		mm	
														
Load Point Ht.	kg	kg	kg	kg	kg	kg	kg	kg	kg	kg	kg	kg	kg	
7.5m												2580*	2580*	5629
6.0m							3860*	3860*				2270*	2270*	6831
4.5m					4440*	4440*	4050*	4050*	2430*	2430*		2150*	2150*	7551
3.0m			7950*	7950*	5520*	5520*	4520*	4520*	3790*	3260		2140*	2140*	7924
1.5m			6890*	6890*	6650*	6650*	5040*	4460	4210*	3180		2230*	2230*	7998
0m			6710*	6710*	7320*	6660	5400*	4310	4210*	3126		2420*	2420*	7784
- 1.5m	5120*	5120*	9850*	9850*	7330*	6540	5370*	4240				2800*	2800*	7254
- 3.0m			9410*	9410*	6530*	6530*	4540*	4290				3590*	3590*	6329

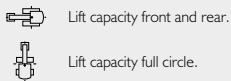

- Notes:**
1. For lifting capacity including bucket, subtract total weight of bucket or bucket and quickhitch from above values.
  2. Lifting capacities are based on ISO 10567, that is: 75% of minimum tipping load or 87% of hydraulic lift capacity, whichever is the less. Lifting capacities marked\* are based on hydraulic capacity.
  3. Lift capacities assume that the machine is on firm, level ground.
  4. Lift capacities may be limited by local regulations. Please refer to your dealer.





**ONE COMPANY, OVER 300 MACHINES.**

Your nearest JCB dealer

**Wheeled Excavator JS175W**  
 Engine power: 129kW (173hp) Bucket capacity: 0.25 – 0.87m<sup>3</sup>  
 Operating weight: 16,256 – 18,982kg

JCB Sales Limited, Rokeceter, Staffordshire, United Kingdom ST14 5JP.  
 Tel: +44 (0)1889 590312 Email: salesinfo@jcb.com  
 Download the very latest information on this product range at: [www.jcb.com](http://www.jcb.com)

©2009 JCB Sales. All rights reserved. No part of this publication may be reproduced, stored in a retrieval system, or transmitted in any form or by any other means, electronic, mechanical, photocopying or otherwise, without prior permission from JCB Sales. All references in this publication to operating weights, sizes, capacities and other performance measurements are provided for guidance only and may vary dependant upon the exact specification of machine. They should not therefore be relied upon in relation to suitability for a particular application. Guidance and advice should always be sought from your JCB Dealer. JCB reserves the right to change specifications without notice. Illustrations and specifications shown may include optional equipment and accessories. All images are correct at time of print. The JCB logo is a registered trademark of J C Bamford Excavators Ltd.

